

## INNER CASING

LENGTH - SEE TABLE

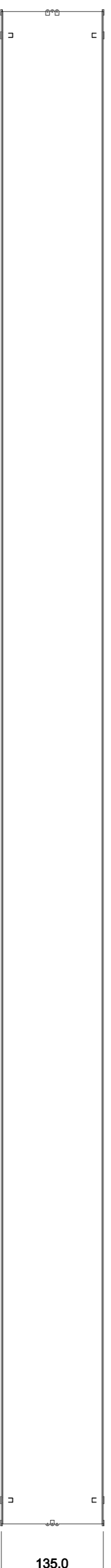
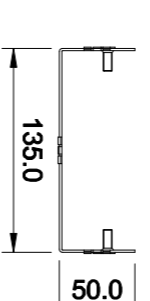
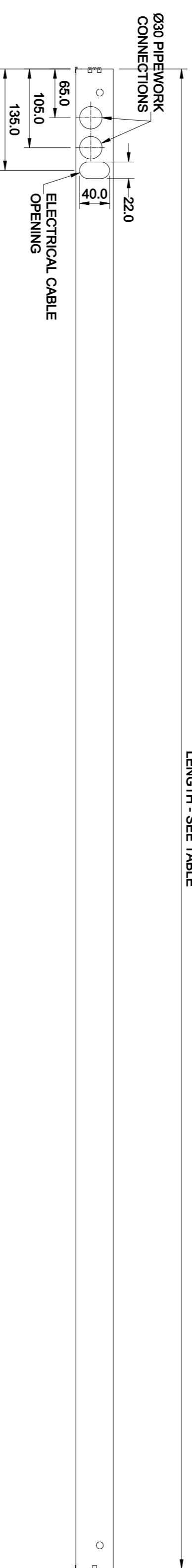

## OUTER CASING

TABLE LENGTH + 4.8mm OVER ENDP.LATES

LENGTH - SEE TABLE

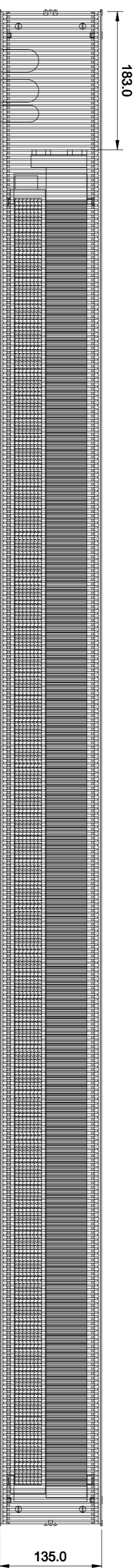
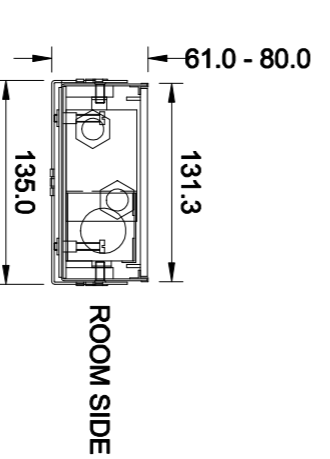
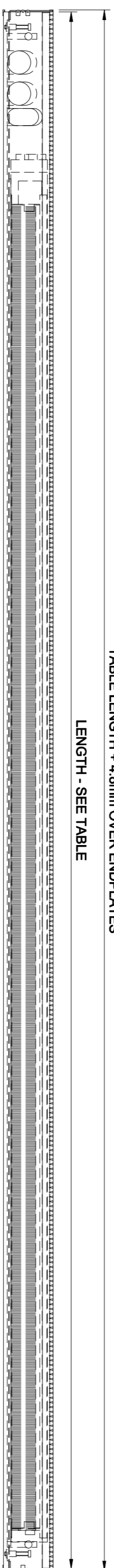

## FULLY ASSEMBLED- INCLUDING GRILLE

LENGTH
600mm
950mm
1300mm
1650mm
2000mm

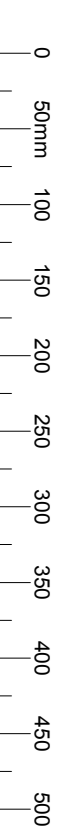

REV.	DESCRIPTION	REV. BY	DATE
0	FIRST ISSUE	A.SAKELBY	09/07/15

PROJECT REF.	MICRO CANAL H006	SHEET NO.	1 of 1	SIZE	A1	PROJECTION	REV.	0	
CUSTOMER:	MICRO CANAL H006	DRAWING NO.	MRF H006	DATE:	09/07/15	INT:	A.S.	SCALE:	1/5
LEDBURY, HEREFORDSHIRE	TEL: +44 (0)1531 631 533	FAX:	+44 (0)1531 631 534						

